

MODEL 5330-200 GRINDER PUMP

EXPLODED VIEW

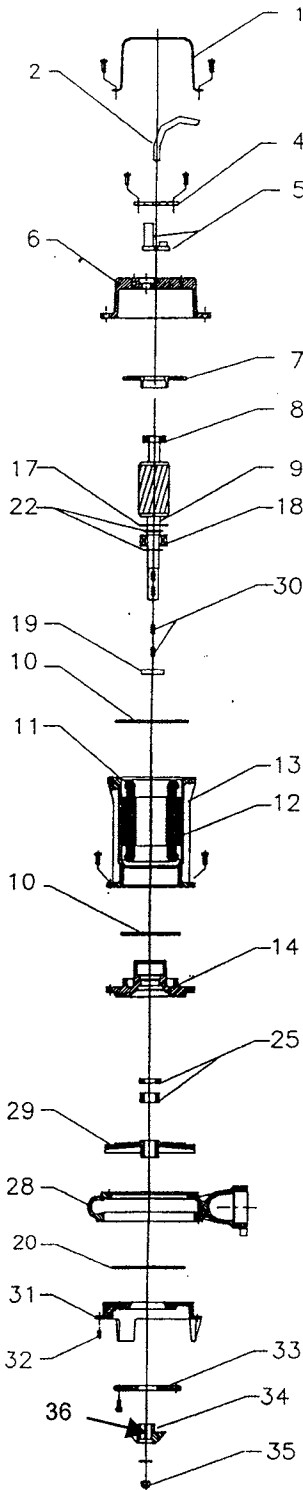

DESCRIPTION	PART NO.
1. HANDLE	
2. CABLE	
3. CABLE CLAMP PLUG	
4. CABLE GLAND	
5. RUBBER GASKET	
6. MOTOR COVER	
7. BEARING SUPPORT	
8. UPPER BEARING HOLDER	
9. SHAFT WITH ROTOR	442003-031
10. O-RING	
11. WINDING	
12. STATOR	
13. MOTOR CASE	
14. LOWER BEARING HOLDER	
15. O-RING	
16. SUPPORT WASHER	
17. SEEGER	
18. LOWER BALL BEARING	
19. LIP SEAL	442003-012
20. O-RING	
21. SEALING FLANGE	
22. SEEGER	
23. SEEGER	
24. GASKET	
25. MECHANICAL SEAL	442003-015
26. O-RING	
27. INTERMEDIATE SUPPORT	
28. PUMP BODY	
29. IMPELLER	
30. KEY	
31. FOOT BASE SUPPORT	
32. REGISTERING GRUB SCREW	
33. CUTTING DISK	442003-033
34. CUTTER	442003-032
35. BOX NUT	
36. REMOVABLE SHIMS	

Armstrong Pumps Inc.
 93 East Avenue
 Buffalo, New York
 U.S.A. 14120-6594
 Tel: (716) 693-8813
 Fax: (716) 693-8970
 Visit us at www.armstrongpumps.com

S.A. Armstrong Limited
 23 Bertrand Avenue
 Toronto, Ontario
 Canada, M1L 2P3
 Tel: (416) 755-2291
 Fax: (416) 759-9101



© S. A. Armstrong Limited 2002

Armstrong Pumps Limited
 Peartree Road, Stanway
 Colchester, Essex
 United Kingdom, C03 0LP
 Tel: 01206-579491
 Fax: 01206-760532

Armstrong Darling
 2200 Place Transcanadienne
 Montreal, Quebec
 Canada, H9P 2X5
 Tel: (514) 421-2424
 Fax: (514) 421-2436

