

## DESIGN ENVELOPE 4200H | END SUCTION BASE MOUNTED | SINGLE PHASE | 0408-001.5 | SUBMITTAL

File No: 100,3444  
Date: APRIL 18, 2016  
Supersedes: NEW  
Date: NEW

Job: \_\_\_\_\_ Representative: \_\_\_\_\_

Order No: \_\_\_\_\_ Date: \_\_\_\_\_

Engineer: \_\_\_\_\_ Submitted by: \_\_\_\_\_ Date: \_\_\_\_\_

Contractor: \_\_\_\_\_ Approved by: \_\_\_\_\_ Date: \_\_\_\_\_

### PUMP DESIGN DATA

No. of pumps: \_\_\_\_\_ Tag: \_\_\_\_\_

Capacity: \_\_\_\_\_ USgpm (L/s) Head: \_\_\_\_\_ ft (m)

Liquid: \_\_\_\_\_ Viscosity: \_\_\_\_\_

Temperature: \_\_\_\_\_ °F (°C) Specific gravity: \_\_\_\_\_

Suction: 6" (150mm) Tapped holes

Discharge: 4" (100mm) Flanged

**UL STD 778 & CSA STD C22.2 NO.108 certified**

### MOTOR DESIGN DATA

HP: 1.5 RPM: 1200 Frame size: 182TC

Enclosure: TEFC Volts: 208 Freq: 60 Hz

Phase: 3 Efficiency: NEMA premium 12.12

### MAXIMUM PUMP OPERATING CONDITIONS

#### ANSI 125

175 psig at 140°F (12 bars at 60°C)

100 psig at 300°F (7 bars at 149°C)

#### ANSI 250

375 psig at 100°F (26 bars at 38°C)

275 psig at 300°F (19 bars at 149°C)

- Tolerance of ±0.125" (±3 mm) should be used
- For exact installation, data please write factory for certified dimensions
- Pump equipped with casing drain plug and ¼" NPT suction and discharge gauge ports

### OPTIONAL EQUIPMENT

### CONTROLS DATA

**Power supply:** Volts: 200-240VAC  
Freq: 50/60Hz Phase: 1

**Sensorless control:** Standard

**Minimum system pressure to be maintained:** \_\_\_\_\_ ft (m)\*

**Protocol (standard):**  Modbus RTU  BACnet™ MS/TP  
 Johnson® N2  Siemens® FLN

**Protocol (optional):**  LonWorks®

**Enclosure:**  Indoor – UL TYPE 12

**Disconnect switch:**  Non-fused

**EMI/RFI control:** 1-phase IVS102 units do not meet the EN61800-3 directive

**Harmonic suppression:** Dual DC-link reactors (Equivalent: 5% AC line reactor) Supporting IEEE 519-1992 requirements\*\*

**Cooling:** Fan-cooled through back channel

**Ambient temperature:** -10°C to +45°C up to 1000 meters above sea level (-14°F to +113°F, 3300 ft)

**Analog I/O:** Two current or voltage inputs, one current output

**Digital I/O:** Six programmable inputs (two can be configured as outputs)

**Pulse inputs:** Two programmable

**Relay outputs:** Two programmable

**Communication port:** 1-RS485, 1-USB

\*If minimum maintained system pressure is not known: Default to 40% of design head

\*\*The IVS 102 drive is a low harmonic drive via built-in DC line reactors. This does not guaranty performance to any system wide harmonic specification or the costs to meet a system wide specification. If supplied with the system electrical details, Armstrong will run a computer simulation of the system wide harmonics. If system harmonic levels are exceeded Armstrong can also recommend additional harmonic mitigation and the costs for such mitigation.

### MECHANICAL SEAL DATA

**Seal type:** AB2

**Stationary seat:** Sintered silicon carbide

**Secondary seal:** Viton

**Rotating hardware:** Stainless steel

**Spring:** Stainless steel

**EXTENDED SPEED**

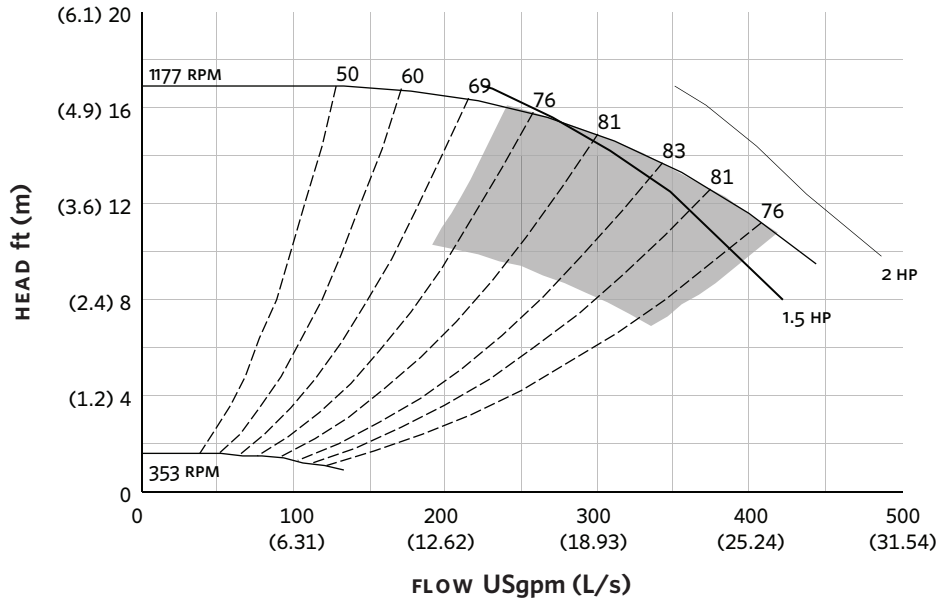

Performance curves are for reference only.  
Confirm current performance data with Armstrong ACE Online selection software.

**DIMENSION DATA**

**INDOOR**  
(UL TYPE 12/ODP)

- Frame size: 182TC
- Size: 6×4×8
- HP: 1.5
- RPM: 1200
- HA: 14.00 (355)
- HB: 30.00 (762)
- HC: 29.63 (753)
- HD: 11.25 (286)
- HE: 6.37 (162)
- HF: 13.00 (330)
- 2HF: 26.00 (660)
- HG: 3.00 (76)
- HI: 25.48 (647)
- HL: 4.50 (114)
- HV: 14.49 (368)
- NAN1: 2.00 (51)
- NAN2: 7.17 (182)
- X: 11.00 (279)
- Y: 4.00 (102)
- Weight: 431 (195.7)

Dimensions - inch (mm)  
Weight - lbs (kg)

**INDOOR**

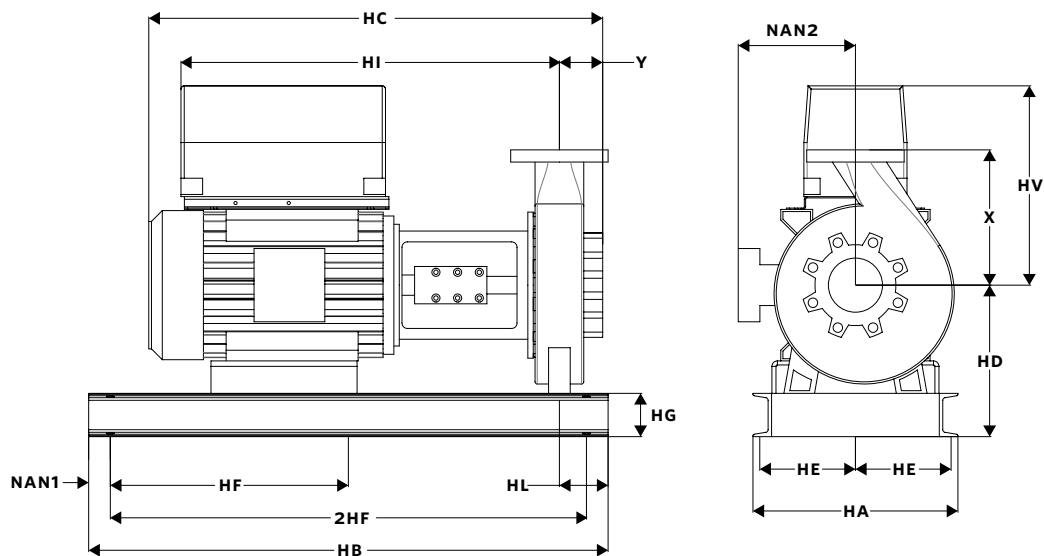

TORONTO  
+1 416 755 2291

BUFFALO  
+1 716 693 8813

BIRMINGHAM  
+44 (0) 8444 145 145

MANCHESTER  
+44 (0) 8444 145 145

BANGALORE  
+91 (0) 80 4906 3555

SHANGHAI  
+86 21 3756 6696

SÃO PAULO  
+55 11 4781 5500